



Electrolux
PROFESSIONAL

**Modular Cooking Range Line
thermaline 85 - 1000 mm Open
base, 1 Side**

ITEM # _____

MODEL # _____

NAME # _____

SIS # _____

AIA # _____



588638 (MB1MCAJ000) Open Base, one-side operated

Short Form Specification

Item No. _____

1000 mm wide open base compartment to store pots, pans, sheet pans, etc. Internal frame for heavy duty sturdiness in stainless steel. Flat surface construction, easily cleanable. IPX5 water resistant certification. Configuration: One side operated freestanding base.

Main Features

- All major components may be easily accessed from the front.
- Open base compartment for storage of pots, pans, sheet pans, etc.
- Unit to be placed below modular top appliances to store pots, pans, sheet pans, etc.

Construction

- 2 mm top in 1.4301 (AISI 304).
- IPX5 water resistance certification.
- Flat surface construction with minimal hidden areas to easily clean all surfaces
- Internal frame for heavy duty sturdiness in stainless steel.
- [NOT TRANSLATED]

Optional Accessories

- Stainless steel front kicking strip, 1000mm width PNC 912636
- Stainless steel side kicking strip left and right, wall mounted, 850mm width PNC 912659
- Stainless steel side kicking strip left and right, back-to-back, 1700mm width PNC 912662
- Stainless steel side panel, 850x700mm, right side, against wall PNC 913003
- Stainless steel side panel, 850x700mm, left side, against wall PNC 913004
- Perforated shelf for warming cabinets and cupboard bases (one-side operated TL80-85-90 and two-side operated for TL80) PNC 913239
- Side reinforced panel only in combination with side shelf, for against the wall installations, right PNC 913261
- Side reinforced panel only in combination with side shelf, for against the wall installations, left PNC 913262
- Shelf fixation for TL80-85-90 one-side operated, TL80 two-side operated PNC 913279
- Stainless steel dividing panel, 850x700mm, (it should only be used between Electrolux Professional thermaline Modular 85 and thermaline C85) PNC 913670

APPROVAL: _____



Experience the Excellence
www.electroluxprofessional.com



Electrolux
PROFESSIONAL

**Modular Cooking Range Line
thermaline 85 - 1000 mm Open
base, 1 Side**

- Stainless steel side panel, 850x700mm, PNC 913686
flush-fitting (it should only be used
against the wall, against a niche and in
between Electrolux Professional
thermaline and ProThermetic
appliances and external appliances -
provided that these have at least the
same dimensions)

**Modular Cooking Range Line
thermaline 85 - 1000 mm Open base, 1 Side**

The company reserves the right to make modifications to the products
without prior notice. All information correct at time of printing.

2025.02.20

Front

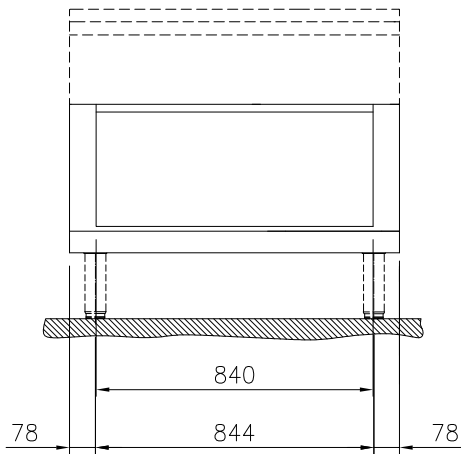

Side

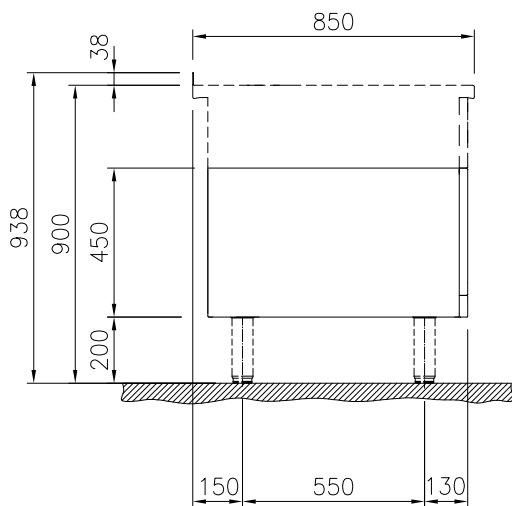

Top

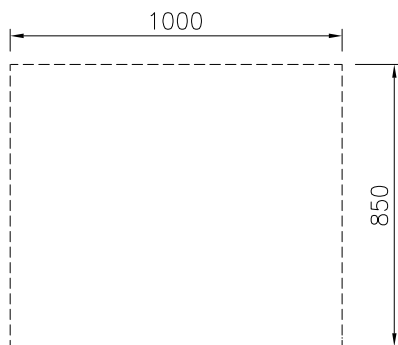
Key Information:

External dimensions, Width:	
588638 (MB1MCAJ000)	1000 mm
External dimensions, Depth:	850 mm
External dimensions, Height:	450 mm
Cupboard Cavity Dimensions (width):	840 mm
Cupboard Cavity Dimensions (height):	330 mm
Cupboard Cavity Dimensions (depth):	740 mm
Net weight:	23 kg